

Molex 43045-1212 PDF

深圳创唯电子有限公司

<http://www.molex-connect.com>

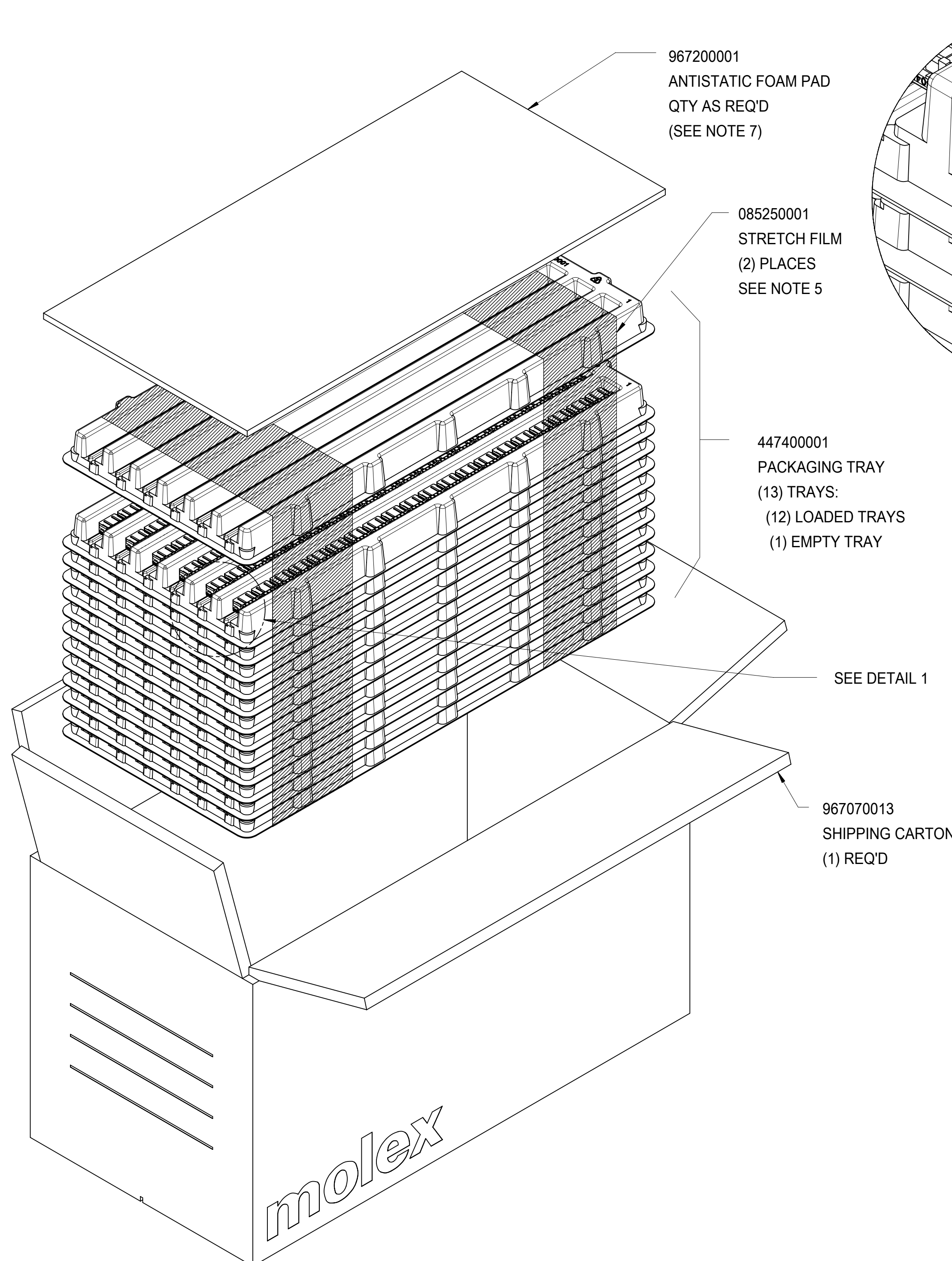

967200001
ANTISTATIC FOAM PAD
QTY AS REQ'D
(SEE NOTE 7)

085250001
STRETCH FILM
(2) PLACES
SEE NOTE 5

447400001
PACKAGING TRAY
(13) TRAYS:
(12) LOADED TRAYS
(1) EMPTY TRAY

967070013
SHIPPING CARTON
(1) REQ'D

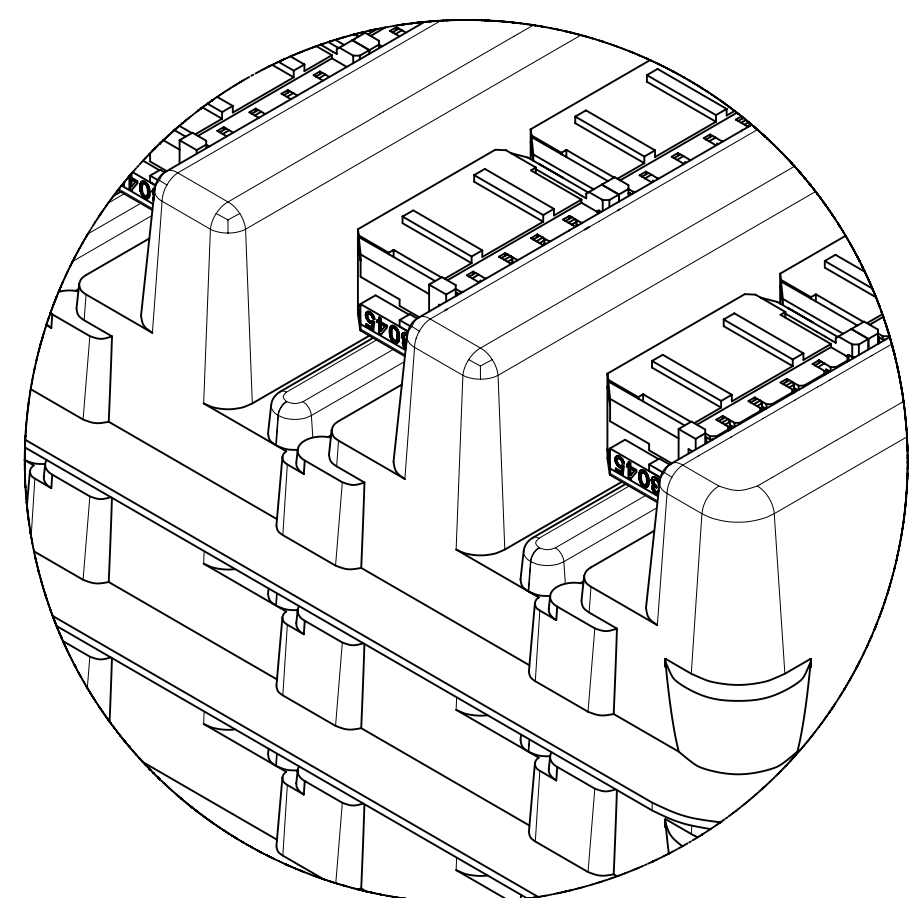

DETAIL 1
SCALE 2:1

PACKAGING INSTRUCTIONS:

1. PRIMARY SHIPPING CARTON TO BE P/N SPECIFIED HAVING A 275 POUND BURST RATING. PREPARE CARTONS BY SEALING BOTTOM FLAPS WITH 2-INCH WIDE CLEAR ADHESIVE TAPE EXTENDING 2 INCHES MINIMUM UP EACH END OF CARTON.
2. LOAD HEADERS INTO TRAY CHANNELS WITH PINS UP IN ORIENTATION SHOWN IN DETAIL 1.
3. TRAYS TO BE LOADED PER QUANTITIES SPECIFIED IN CHART. 12 TRAYS TO BE FULLY LOADED. TOP 13TH TRAY IS EMPTY.
4. TRAYS TO BE STACKED IN THE SAME ORIENTATION.
5. STACKED TRAYS TO BE BUNDLED WITH 5-INCH WIDE STRETCH FILM WRAPPED 3 TIMES AROUND EACH END OF STACK AS SHOWN.
6. BUNDLED TRAYS TO BE INSERTED INTO CARTON.
7. ANTISTAT FOAM PAD TO BE ADDED IN BOTTOM OF CARTON BELOW TRAY BUNDLE AND ADDED ON TOP OF TRAY BUNDLE AS REQUIRED TO FILL CARTON. NOTE: QUANTITY OF FOAM FILLER PADS USED SHOULD BE ENOUGH TO FILL CARTON BUT NOT CAUSE TOP OF CARTON TO BULGE WHEN FLAPS ARE CLOSED. FOAM PADS ARE ALSO TO BE ADDED ON END SIDES OF CARTON WHEN PARTS ARE PACKAGED IN PET TRAYS (NOT REQUIRED/OPTIONAL FOR PVC TRAYS).
8. CLOSE AND SEAL LONG FLAPS OF CARTON WITH 2-INCH WIDE ADHESIVE TAPE THAT SHOULD EXTEND A MINIMUM OF 2 INCHES DOWN SIDE OF CARTON.
9. APPLY APPROPRIATE LABELS FOR PRODUCT ID, SHIPPING AND SAFETY AGENCY.

CKT SIZE	PARTS PER CHANNEL	PARTS PER TRAY	PARTS PER CARTON (SPQ)
2	44	264	3168
4	31	186	2232
6	24	144	1728
8	20	120	1440
10	17	102	1224
12	14	84	1008
14	13	78	936
16	11	66	792
18	10	60	720
20	9	54	648
22	8	48	576
24	8	48	576

SYMBOLS THIS DRAWING CONTAINS INFORMATION THAT IS PROPRIETARY TO MOLEX ELECTRONIC TECHNOLOGIES, LLC AND SHOULD NOT BE USED WITHOUT WRITTEN PERMISSION DIMENSION UNITS: MM SCALE: 1:2 GENERAL TOLERANCES (UNLESS SPECIFIED) 4 PLACES ± ± 3 PLACES ± ± 2 PLACES ± ± 1 PLACE ± ± 0 PLACES ± ± ANGULAR TOL ± ° DRAFT WHERE APPLICABLE MUST REMAIN WITHIN DIMENSIONS THIRD ANGLE PROJECTION DRAWING SERIES: C-SIZE 70873	CURRENT REV DESC: UPDATE NOTE 7				
	EC NO: 603708				
DRWN: MPETROVICH 2018/08/28		DRWN: RFC_PLMIMP 2017/11/10		DOCUMENT NUMBER: PK-70873-0314	
CHK'D: SSOUSEK 2018/09/28		APPR: REDGLE 2001/03/12		DOC TYPE: PDD	
APPR: FSMITH 2018/10/02		INITIAL REVISION:		DOC PART: 001	
MATERIAL NUMBER: NA		CUSTOMER: GENERAL MARKET		REVISION: J	
SHEET NUMBER: 1 OF 1					



TEST SUMMARY

Micro-Fit (3.0) Connector Systems (Reflowed Matte Tin Plating) Single and Dual Row – Wire to Board

1.0 SCOPE

This Test Summary covers the Micro-Fit 3.00 mm (.118 inch) centerline (pitch) printed circuit board (PCB) connector series with reflowed matte tin over nickel plating mated with the Micro-Fit receptacle connector series terminated with 20-30 AWG wire using crimp technology with Hot Tin Dip plating.

2.0 PRODUCT DESCRIPTION

2.1 PRODUCT NAME, SERIES, AND PART NUMBER(S)

Micro-Fit (3.0) Receptacle Series: 43645, 43025
Micro-Fit (3.0) Header Series: 43650, 43045
Micro-Fit (3.0) Female Crimp Terminal Series: 43030

2.1.1 PART NUMBERS TESTED:

Micro-Fit (3.0) Female Crimp Terminal: 43030-0001 (with 20awg wire)
Micro-Fit (3.0) Receptacle Housing: 43025-1000 (10 circuit)
Micro-Fit (3.0) Header: 43045-1012 (Dual Row Thru Hole 10 circuit)

2.2 DIMENSIONS, MATERIALS, PLATINGS AND MARKINGS

See the appropriate sales drawings for information on dimensions, materials, plating, and markings.

2.3 PRODUCT SPECIFICATION TITLE AND DOCUMENT NUMBER

Product Specification: Micro-Fit (3.0) Single Row Document Number: PS-43650
Product Specification: Micro-Fit (3.0) Dual Row Document Number: PS-43045

3.0 TEST OBJECTIVE

Evaluate the durability and solderability performance of a Micro-Fit contact interface and solder tail with reflowed matte tin over nickel finish for wire-to-board applications. Bright tin over nickel was also tested for comparison.

4.0 CONCLUSION

The bright tin and reflowed matte tin header pins mated to the hot tin dipped 43030 terminal exhibited comparable contact resistance performance following the 30 durability cycles. Neither plating exceeded the 10 milliohm maximum delta requirement following durability.

The bright tin and reflowed matte tin header pins displayed similar solderability performance. Regardless of the solder pot temperature (245°C or 260°C), the solder coating quickly adhered with no signs of dewetting or non-wetting.

<u>REVISION:</u> A	<u>ECR/ECN INFORMATION:</u> EC No: 105822 DATE: 2015/10/29	<u>TITLE:</u> TEST SUMMARY MICRO-FIT (3.0) CONNECTOR SERIES (REFLOWED MATTE TIN)	<u>SHEET No.</u> 1 of 6
<u>DOCUMENT NUMBER:</u> 430450004-TS	<u>CREATED / REVISED BY:</u> CSLAFTER	<u>CHECKED BY:</u> SSOUSEK	<u>APPROVED BY:</u> FSMITH



TEST SUMMARY

5.0 TESTING PROCEDURES

5.1 SOLDERABILITY

Microfit header assemblies were tested using the dip and look solderability procedure outlined in SMES-152 using a solder pot temperature of 245°C +/- 5°C and 260°C +/- 5°C with lead free solder. (Reference SMES-152)

5.2 DURABILITY

Samples were cycled (mated and unmated) 30 times by hand at a maximum rate of 300 cycles/hr. Latch mechanisms were disabled during testing. (Reference EIA-364-09)

5.3 LOW-LEVEL CONTACT RESISTANCE

Low-level contact resistance measurements were taken using a 4-point, dry circuit method. The bulk resistance of the specimen and its conductor are included in the measurement. Initial measurements are acquired and used as a baseline in the data analysis for determining the change in resistance (Delta-R) at interim measurement points throughout the testing sequence. (Reference EIA-364-23)

<u>REVISION:</u> A	<u>ECR/ECN INFORMATION:</u> EC No: 105822 DATE: 2015/10/29	<u>TITLE:</u> TEST SUMMARY MICRO-FIT (3.0) CONNECTOR SERIES (REFLOWED MATTE TIN)	<u>SHEET No.</u> 2 of 6
<u>DOCUMENT NUMBER:</u> 430450004-TS	<u>CREATED / REVISED BY:</u> CSLAFTER	<u>CHECKED BY:</u> SSOUSEK	<u>APPROVED BY:</u> FSMITH



TEST SUMMARY

6.0 PERFORMANCE RESULTS

6.1 SOLDERABILITY



Unsoldered Bright Tin

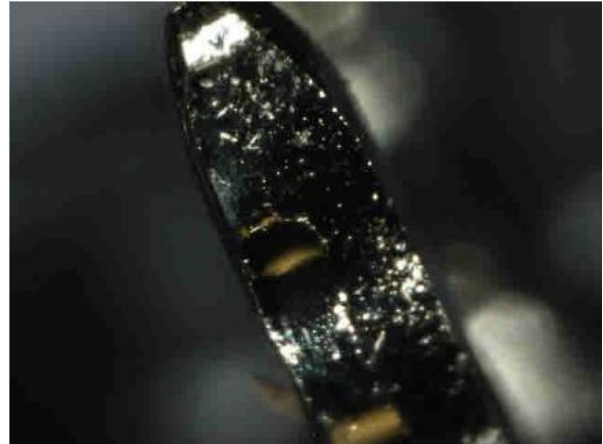

Unsoldered Reflowed Matte Tin

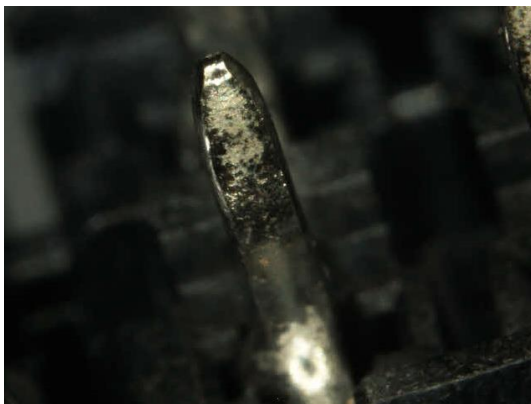

Bright Tin – after 245°C



Reflowed Matte Tin – after 245°C

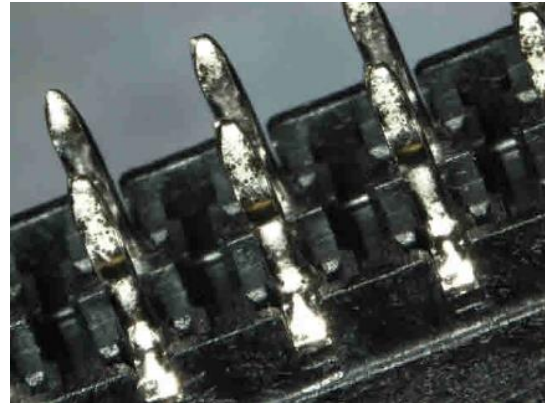
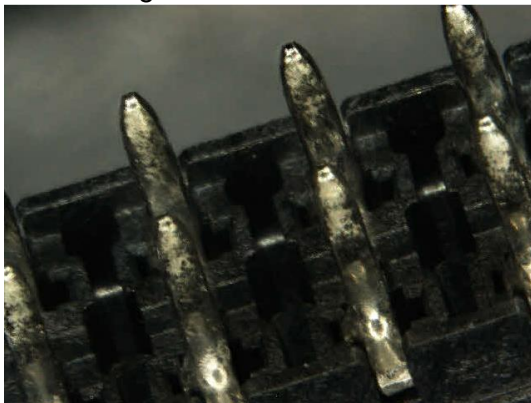

REVISION: A	ECR/ECN INFORMATION: EC No: 105822 DATE: 2015/10/29	TITLE: TEST SUMMARY MICRO-FIT (3.0) CONNECTOR SERIES (REFLOWED MATTE TIN)	SHEET No. 3 of 6
DOCUMENT NUMBER: 430450004-TS	CREATED / REVISED BY: CSLAFTER	CHECKED BY: SSOUSEK	APPROVED BY: FSMITH



TEST SUMMARY



Bright Tin – after 260°C



Reflowed Matte Tin – after 260°C

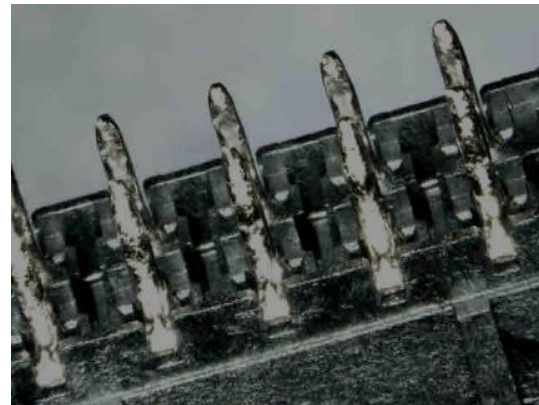
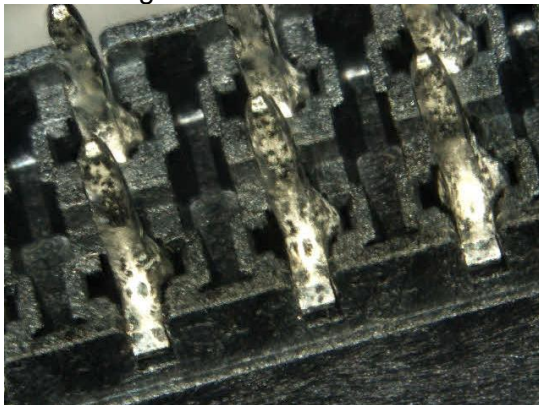

6.2 DURABILITY

Micro-fit Durability 30 cycles DeltaR (mOhm)					
		Reflow Matte Tin		Bright Tin	
		Initial	Post 30 cycles	Initial	Post 30 cycles
Minimum		7.79	-0.14	7.77	-0.05
Maximum		8.24	0.57	8.15	0.32
Average		7.96	0.12	7.94	0.11

Requirement: 10 milliohm Delta maximum from initial.

REVISION: A	ECR/ECN INFORMATION: EC No: 105822 DATE: 2015/10/29	TITLE: TEST SUMMARY MICRO-FIT (3.0) CONNECTOR SERIES (REFLOWED MATTE TIN)	SHEET No. 4 of 6
DOCUMENT NUMBER: 430450004-TS		CREATED / REVISED BY: CSLAFTER	CHECKED BY: SSOUSEK
		APPROVED BY: FSMITH	



TEST SUMMARY

APPENDIX A TEST SEQUENCES

<u>REVISION:</u> A	<u>ECR/ECN INFORMATION:</u> EC No: 105822 DATE: 2015/10/29	<u>TITLE:</u> TEST SUMMARY MICRO-FIT (3.0) CONNECTOR SERIES (REFLOWED MATTE TIN)	<u>SHEET No.</u> 5 of 6
<u>DOCUMENT NUMBER:</u> 430450004-TS	<u>CREATED / REVISED BY:</u> CSLAFTER	<u>CHECKED BY:</u> SSOUSEK	<u>APPROVED BY:</u> FSMITH



TEST SUMMARY

A.1 TEST SEQUENCES

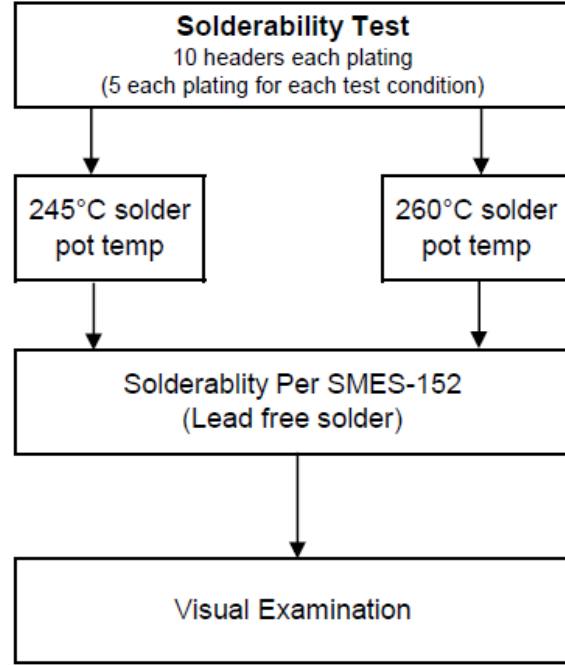
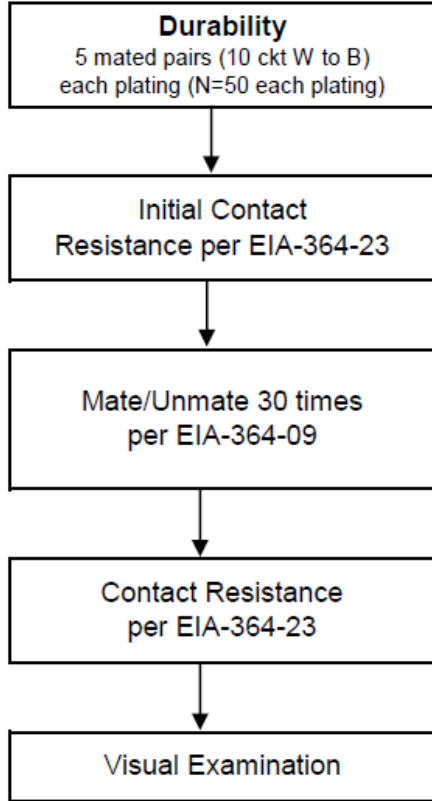

REVISION: A	ECR/ECN INFORMATION: EC No: 105822 DATE: 2015/10/29	TITLE: TEST SUMMARY MICRO-FIT (3.0) CONNECTOR SERIES (REFLOWED MATTE TIN)	SHEET No. 6 of 6
DOCUMENT NUMBER: 430450004-TS	CREATED / REVISED BY: CSLAFTER	CHECKED BY: SSOUSEK	APPROVED BY: FSMITH

Micro-Fit (3.0) Connector System (Wire to Wire & Wire to Board)

1.0 SCOPE

This Test Specification covers the 3.00 mm (.118 inch) centerline (pitch) connector series terminated with 20-30 AWG wire using crimp technology.

2.0 PRODUCT DESCRIPTION

2.1 PRODUCT NAME, SERIES, AND PART NUMBER(S)

Micro-Fit (3.0) Receptacle Series : 43025, 43645, 44133 (BMI)

Micro-Fit (3.0) Plug Series : 43020, 43640, 44300 (BMI)

Micro-Fit (3.0) Right Angle & Vertical Header Series : 43045, 43650, 44067

Micro-Fit (3.0) Compliant Pin Vertical Header Series : 44914

Micro-Fit (3.0) Female Crimp Terminal Series : 43030

Micro-Fit (3.0) Male Crimp Terminal Series : 43031

Micro-Fit (3.0) Female Crimp Terminal with Lubricant : 45773

2.1.1 SERIES NUMBERS TESTED

Micro-Fit (3.0) Receptacle : 43025

Micro-Fit (3.0) Plug : 43020

Micro-Fit (3.0) Right Angle & Vertical Headers : 43045

Micro-Fit (3.0) Female Crimp Terminal : 43030

Micro-Fit (3.0) Male Crimp Terminal : 43031

2.2 DIMENSIONS, MATERIALS, PLATINGS AND MARKINGS

See the appropriate sales drawings for information on dimensions, materials, plating, and markings.

2.3 PRODUCT SPECIFICATION TITLE AND DOCUMENT NUMBER

Product Specification Micro-Fit Dual Row Connectors

Document Number: PS-43045

Product Specification Micro-Fit Single Row Connectors

Document Number: PS-43650

Product Specification Micro-Fit (3.0) BMI Floating Connector System

Document Number: PS-44300-001

3.0 APPLICABLE DOCUMENTS AND SPECIFICATIONS

3.1 TESTING PROCEDURES AND SEQUENCES

EIA-364-1000.01

<u>REVISION:</u> A2	<u>ECR/ECN INFORMATION:</u> EC No: 109530 DATE: 2016 / 10 /18	<u>TITLE:</u> TEST SUMMARY MICRO-FIT (3.0) CONNECTORS	<u>SHEET No.</u> 1 of 10
<u>DOCUMENT NUMBER:</u> TS-43045-001	<u>CREATED / REVISED BY:</u> JDFOX	<u>CHECKED BY:</u> SSOUSEK	<u>APPROVED BY:</u> FSMITH

3.2 OTHER DOCUMENTS AND SPECIFICATIONS

None

4.0 QUALIFICATION

Laboratory conditions and sample selection are in accordance with **EIA-364**.

5.0 PERFORMANCE RESULTS

5.1 ELECTRICAL PERFORMANCE RESULTS

WIRE TO WIRE CONFIGURATION

ITEM	DESCRIPTION	TREATMENT	REQUIREMENT	MEAN	MINIMUM	MAXIMUM
1A	CONTACT RESISTANCE (LOW LEVEL)	Initial **	10 milliohms MAXIMUM	19.95 mΩ	19.74 mΩ	20.40 mΩ
		After Durability Δ mΩ	20 milliohms MAXIMUM	-0.23 mΩ	-0.03 mΩ	0.67 mΩ
		After Temperature Life Δ mΩ	20 milliohms MAXIMUM	0.38 mΩ	0.08 mΩ	1.01 mΩ
		After Reseating Δ mΩ	20 milliohms MAXIMUM	0.25 mΩ	-0.53 mΩ	1.32 mΩ

NOTE : ** APPROXIMATELY 16.6 mΩ OF THE MEASUREMENT VALUE IS ATTRIBUTED TO THE BULK RESISTANCE OF THE 13 INCHES OF WIRE USED IN SAMPLE PREPARATION.

WIRE TO BOARD CONFIGURATION

ITEM	DESCRIPTION	TREATMENT	REQUIREMENT	MEAN	MINIMUM	MAXIMUM
1B	CONTACT RESISTANCE (LOW LEVEL)	Initial	10 milliohms MAXIMUM	4.75 mΩ	4.55 mΩ	4.98 mΩ
		After Durability Δ mΩ	20 milliohms MAXIMUM	-0.23 mΩ	-0.03 mΩ	0.67 mΩ
		After Temperature Life Δ mΩ	20 milliohms MAXIMUM	0.38 mΩ	0.08 mΩ	1.01 mΩ
		After Reseating Δ mΩ	20 milliohms MAXIMUM	0.25 mΩ	-0.53 mΩ	1.32 mΩ

NOTE : SEE APPENDIX "A" FOR TEST SEQUENCE DESCRIPTION.

REVISION: A2	ECR/ECN INFORMATION: EC No: 109530 DATE: 2016 / 10 /18	TITLE: TEST SUMMARY MICRO-FIT (3.0) CONNECTORS	SHEET No. 2 of 10
DOCUMENT NUMBER: TS-43045-001	CREATED / REVISED BY: JDFOX	CHECKED BY: SSOUSEK	APPROVED BY: FSMITH

5.1 ELECTRICAL PERFORMANCE RESULTS (continued)

WIRE TO WIRE CONFIGURATION

ITEM	DESCRIPTION	TREATMENT	REQUIREMENT	MEAN	MINIMUM	MAXIMUM
2A	Contact Resistance (Low Level)	Initial **	10 milliohms MAXIMUM	20.01 mΩ	19.59 mΩ	23.29 mΩ
		After Durability Δ mΩ	20 milliohms MAXIMUM	0.19 mΩ	-0.02 mΩ	0.64 mΩ
		After Thermal Shock Δ mΩ	20 milliohms MAXIMUM	0.34 mΩ	0.08 mΩ	0.74 mΩ
		After Cyclic Humidity Δ mΩ	20 milliohms MAXIMUM	0.62 mΩ	0.14 mΩ	1.77 mΩ
		After Reseating Δ mΩ	20 milliohms MAXIMUM	0.61 mΩ	0.11 mΩ	3.09 mΩ

NOTE : ** APPROXIMATELY 16.6 mΩ OF THE MEASUREMENT VALUE IS ATTRIBUTED TO THE BULK RESISTANCE OF THE 13 INCHES OF WIRE USED IN SAMPLE PREPARATION.

WIRE TO BOARD CONFIGURATION

ITEM	DESCRIPTION	TREATMENT	REQUIREMENT	MEAN	MINIMUM	MAXIMUM
2B	Contact Resistance (Low Level)	Initial	10 milliohms MAXIMUM	4.75 mΩ	4.55 mΩ	4.98 mΩ
		After Durability Δ mΩ	20 milliohms MAXIMUM	0.42 mΩ	-0.02 mΩ	2.03 mΩ
		After Thermal Shock Δ mΩ	20 milliohms MAXIMUM	1.56 mΩ	0.25 mΩ	5.71 mΩ
		After Cyclic Humidity Δ mΩ	20 milliohms MAXIMUM	1.28 mΩ	0.15 mΩ	4.60 mΩ
		After Reseating Δ mΩ	20 milliohms MAXIMUM	2.19 mΩ	0.23 mΩ	8.04 mΩ

NOTE : SEE APPENDIX "A" FOR TEST SEQUENCE DESCRIPTION

REVISION: A2	ECR/ECN INFORMATION: EC No: 109530 DATE: 2016 / 10 /18	TITLE: TEST SUMMARY MICRO-FIT (3.0) CONNECTORS	SHEET No. 3 of 10
DOCUMENT NUMBER: TS-43045-001	CREATED / REVISED BY: JDFOX	CHECKED BY: SSOUSEK	APPROVED BY: FSMITH

5.1 ELECTRICAL PERFORMANCE RESULTS (continued)

WIRE TO BOARD CONFIGURATION – 2 CIRCUIT VERSION

ITEM	DESCRIPTION	TREATMENT	REQUIREMENT	MEAN	MINIMUM	MAXIMUM
3A	Contact Resistance (Low Level)	Initial **	10 milliohms MAXIMUM	10.26 mΩ	10.17 mΩ	10.46 mΩ
		After Durability Δ mΩ	20 milliohms MAXIMUM	0.75 mΩ	0.16 mΩ	1.57 mΩ
		After Temperature Life Pre-Conditioned Δ mΩ	20 milliohms MAXIMUM	1.88 mΩ	0.58 mΩ	3.77 mΩ
		After Vibration Δ mΩ	20 milliohms MAXIMUM	1.28 mΩ	0.15 mΩ	4.60 mΩ
		No Discontinuity	Discontinuity < 1 microsecond			

NOTE : ** APPROXIMATELY 7.8 mΩ OF THE MEASUREMENT VALUE IS ATTRIBUTED TO THE BULK RESISTANCE OF THE 6 INCHES OF WIRE USED IN SAMPLE PREPARATION.

WIRE TO BOARD CONFIGURATION –12 CIRCUIT VERSION

ITEM	DESCRIPTION	TREATMENT	REQUIREMENT	MEAN	MINIMUM	MAXIMUM
3B	Contact Resistance (Low Level)	Initial **	10 milliohms MAXIMUM	10.24 mΩ	9.85 mΩ	10.52 mΩ
		After Durability Δ mΩ	20 milliohms MAXIMUM	0.41 mΩ	0.14 mΩ	2.13 mΩ
		After Temperature Life Pre-Conditioned Δ mΩ	20 milliohms MAXIMUM	0.81 mΩ	0.16 mΩ	3.68 mΩ
		After Vibration Δ mΩ	20 milliohms MAXIMUM	1.14 mΩ	0.25 mΩ	3.56 mΩ
		No Discontinuity	Discontinuity < 1 microsecond			

NOTES : ** APPROXIMATELY 7.8 mΩ OF THE MEASUREMENT VALUE IS ATTRIBUTED TO THE BULK RESISTANCE OF THE 6 INCHES OF WIRE USED IN SAMPLE PREPARATION.

SEE APPENDIX "A" FOR TEST SEQUENCE DESCRIPTION

REVISION: A2	ECR/ECN INFORMATION: EC No: 109530 DATE: 2016 / 10 /18	TITLE: TEST SUMMARY MICRO-FIT (3.0) CONNECTORS	SHEET No. 4 of 10
DOCUMENT NUMBER: TS-43045-001	CREATED / REVISED BY: JDFOX	CHECKED BY: SSOUSEK	APPROVED BY: FSMITH

5.1 ELECTRICAL PERFORMANCE RESULTS (continued)

WIRE TO WIRE CONFIGURATION

ITEM	DESCRIPTION	TREATMENT	REQUIREMENT	MEAN	MINIMUM	MAXIMUM
4A	Contact Resistance (Low Level)	Initial **	10 milliohms MAXIMUM	20.07 mΩ	19.95 mΩ	20.50 mΩ
		After Durability Δ mΩ	20 milliohms MAXIMUM	0.31 mΩ	-0.02 mΩ	0.72 mΩ
		After Temperature Life Pre-Conditioned Δ mΩ	20 milliohms MAXIMUM	0.34 mΩ	0.07 mΩ	0.97 mΩ
		Thermal Cycling 167 Hours Δ mΩ	20 milliohms MAXIMUM	0.42 mΩ	0.10 mΩ	2.01 mΩ
		Thermal Cycling 334 Hours Δ mΩ	20 milliohms MAXIMUM	0.41 mΩ	-0.06 mΩ	1.03 mΩ
		Thermal Cycling 500 Hours Δ mΩ	20 milliohms MAXIMUM	0.64 mΩ	0.03 mΩ	2.79 mΩ
		After Reseating Δ mΩ	20 milliohms MAXIMUM	0.54 mΩ	0.14 mΩ	2.45 mΩ

NOTES : ** APPROXIMATELY 16.6 mΩ OF THE MEASUREMENT VALUE IS ATTRIBUTED TO THE BULK RESISTANCE OF THE 13 INCHES OF WIRE USED IN SAMPLE PREPARATION.

SEE APPENDIX "A" FOR TEST SEQUENCE DESCRIPTION

REVISION: A2	ECR/ECN INFORMATION: EC No: 109530 DATE: 2016 / 10 /18	TITLE: TEST SUMMARY MICRO-FIT (3.0) CONNECTORS	SHEET No. 5 of 10
DOCUMENT NUMBER: TS-43045-001	CREATED / REVISED BY: JDFOX	CHECKED BY: SSOUSEK	APPROVED BY: FSMITH

5.1 ELECTRICAL PERFORMANCE RESULTS (continued)

WIRE TO BOARD CONFIGURATION

ITEM	DESCRIPTION	TREATMENT	REQUIREMENT	MEAN	MINIMUM	MAXIMUM
4B	Contact Resistance (Low Level)	Initial	10 milliohms MAXIMUM	4.78 mΩ	4.56 mΩ	5.53 mΩ
		After Durability Δ mΩ	20 milliohms MAXIMUM	0.48 mΩ	0.06 mΩ	2.35 mΩ
		After Temperature Life Pre-Conditioned Δ mΩ	20 milliohms MAXIMUM	1.07 mΩ	0.13 mΩ	5.80 mΩ
		Thermal Cycling 167 Hours Δ mΩ	20 milliohms MAXIMUM	1.38 mΩ	0.30 mΩ	4.68 mΩ
		Thermal Cycling 334 Hours Δ mΩ	20 milliohms MAXIMUM	1.63 mΩ	0.31 mΩ	5.17 mΩ
		Thermal Cycling 500 Hours Δ mΩ	20 milliohms MAXIMUM	3.04 mΩ	0.69 mΩ	8.51 mΩ
		After Reseating Δ mΩ	20 milliohms MAXIMUM	3.48 mΩ	0.41 mΩ	8.94 mΩ

NOTE : SEE APPENDIX "A" FOR TEST SEQUENCE DESCRIPTION

REVISION: A2	ECR/ECN INFORMATION: EC No: 109530 DATE: 2016 / 10 /18	TITLE: TEST SUMMARY MICRO-FIT (3.0) CONNECTORS	SHEET No. 6 of 10
DOCUMENT NUMBER: TS-43045-001	CREATED / REVISED BY: JDFOX	CHECKED BY: SSOUSEK	APPROVED BY: FSMITH

5.1 ELECTRICAL PERFORMANCE RESULTS (continued)

ITEM	DESCRIPTION	WIRE GAUGE	REQUIREMENT	AMPERAGE
5	Temperature Rise & Current Cycling	30 AWG	30°C Max. Temp. Rise	2.5 Amps
		26 AWG	30°C Max. Temp. Rise	3.0 Amps
		24 AWG	30°C Max. Temp. Rise	4.0 Amps
		20 AWG	30°C Max. Temp. Rise	5.5 Amps

5.2 MECHANICAL PERFORMANCE RESULTS

ITEM	DESCRIPTION	Wire Gauge	REQUIREMENT	MEAN	MINIMUM	MAXIMUM
6	Wire Pullout Force (Newtons)	20 AWG	57.8 N Minimum	127.4	117.5	134.7
		22 AWG	35.6 N Minimum	86.1	80.2	90.4
		24 AWG	22.2 N Minimum	53.6	44.7	58.08
		26 AWG	13.3 N Minimum	36.1	33.8	38.3
		28 AWG	8.9 N Minimum	21.1	18.1	23.2
		30 AWG	6.6 N Minimum	18.2	13.5	24.6

ITEM	DESCRIPTION	REQUIREMENT	MEAN	MINIMUM	MAXIMUM
7	Contact Normal Force (grams)	275 g Min	331 g	322 g	343 g

REVISION: A2	ECR/ECN INFORMATION: EC No: 109530 DATE: 2016 / 10 /18	TITLE: TEST SUMMARY MICRO-FIT (3.0) CONNECTORS	SHEET No. 7 of 10
DOCUMENT NUMBER: TS-43045-001	CREATED / REVISED BY: JDFOX	CHECKED BY: SSOUSEK	APPROVED BY: FSMITH

APPENDIX A
TEST SEQUENCES

REVISION: A2	ECR/ECN INFORMATION: EC No: 109530 DATE: 2016 / 10 /18	TITLE: TEST SUMMARY MICRO-FIT (3.0) CONNECTORS	SHEET No. 8 of 10
DOCUMENT NUMBER: TS-43045-001	CREATED / REVISED BY: JDFOX	CHECKED BY: SSOUSEK	APPROVED BY: FSMITH

A.1 TEST SEQUENCES

SEQUENCE 1 1A Wire to Wire 1B Wire to Board

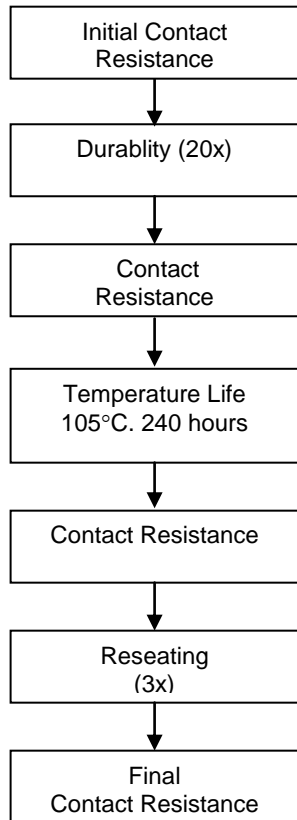

SEQUENCE 2 2A Wire to Wire 2B Wire to Board

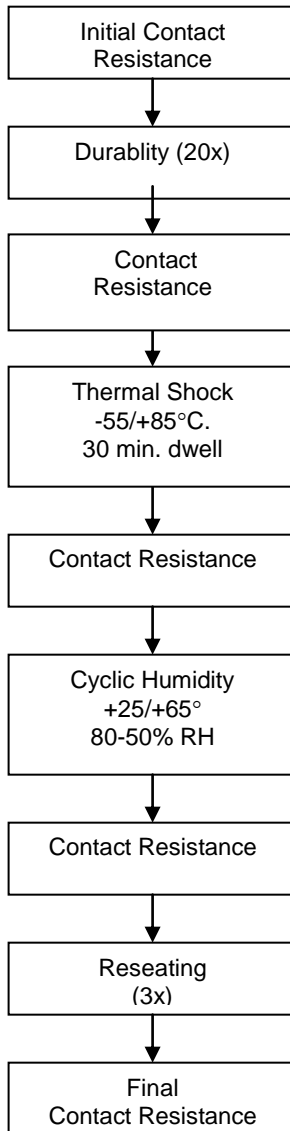

REVISION: A2	ECR/ECN INFORMATION: EC No: 109530 DATE: 2016 / 10 /18	TITLE: TEST SUMMARY MICRO-FIT (3.0) CONNECTORS	SHEET No. 9 of 10
DOCUMENT NUMBER: TS-43045-001	CREATED / REVISED BY: JDFOX	CHECKED BY: SSOUSEK	APPROVED BY: FSMITH

A.1 TEST SEQUENCES (continued)

SEQUENCE 3 3A Wire to Wire 3B Wire to Board

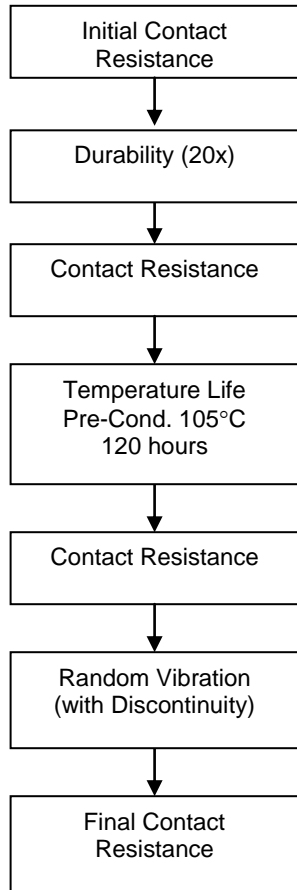

SEQUENCE 4 4A Wire to Wire 4B Wire to Board

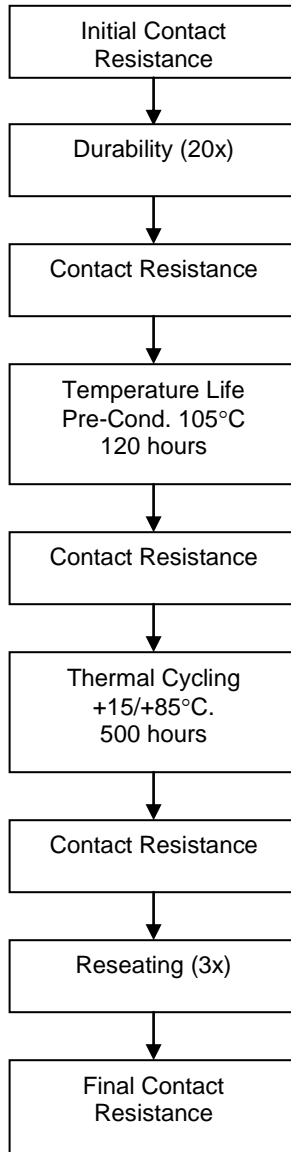

REVISION: A2	ECR/ECN INFORMATION: EC No: 109530 DATE: 2016 / 10 /18	TITLE: TEST SUMMARY MICRO-FIT (3.0) CONNECTORS	SHEET No. 10 of 10
DOCUMENT NUMBER: TS-43045-001	CREATED / REVISED BY: JDFOX	CHECKED BY: SSOUSEK	APPROVED BY: FSMITH



TEST SUMMARY

LOW FORCE MICRO-FIT SERIES (46235)



1.0 SCOPE

This Test Summary covers the 3.00 mm (.118 inch) centerline (pitch) receptacles terminated with 46235 low force crimp terminals when mated with either printed circuit board (PCB) headers or plugs terminated with 20 to 30 AWG wire using crimp technology.

2.0 PRODUCT DESCRIPTION

2.1 PRODUCT NAME, SERIES, AND PART NUMBER(S)

Micro-Fit (3.0) Receptacle Series : 43025, 43645, 44133 (BMI)

Micro-Fit (3.0) Plug Series : 43020, 43640, 44300 (BMI)

Micro-Fit (3.0) Right Angle & Vertical Header Series : 43045, 43650, 44067

Micro-Fit (3.0) Compliant Pin Vertical Header Series : 44914

Micro-Fit (3.0) Female Crimp Terminal Series : 46235

Micro-Fit (3.0) Male Crimp Terminal Series : 43031

2.1.1 SERIES NUMBERS TESTED

Micro-Fit (3.0) Receptacle : 43025

Micro-Fit (3.0) Plug : 43020

Micro-Fit (3.0) Right Angle & Vertical Headers : 43045

Micro-Fit (3.0) Female Crimp Terminal : 46235

Micro-Fit (3.0) Male Crimp Terminal : 43031

2.2 DIMENSIONS, MATERIALS, PLATINGS AND MARKINGS

Refer to the appropriate sales drawings for information on dimensions, materials, platings and markings.

2.3 PRODUCT SPECIFICATION TITLE AND DOCUMENT NUMBER

Title: Product Specification for Micro-fit Low Mate Force Connector System

Document No.: PS-46235-001

REVISION: D1	ECR/ECN INFORMATION: EC No: 109530 DATE: 2016 / 10 / 19	TITLE: TEST SUMMARY FOR 46235 LOW FORCE MICRO-FIT CONNECTOR SYSTEM	SHEET No. 1 of 18
DOCUMENT NUMBER: TS-46235-001	CREATED / REVISED BY: JDFOX	CHECKED BY: SSOUSEK	APPROVED BY: FSMITH



TEST SUMMARY

3.0 APPLICABLE DOCUMENTS AND SPECIFICATIONS

3.1 TESTING SEQUENCES AND PROCEDURES

Reference Appendix 1

3.2 OTHER DOCUMENTS AND SPECIFICATIONS

SD-46235-001

PS-46235-001

4.0 QUALIFICATION

Laboratory conditions and sample selection are in accordance with EIA-364.

5.0 PERFORMANCE

5.1 ELECTRICAL/ENVIRONMENTAL PERFORMANCE RESULTS

(Note that measured LLCR values are for one mated interface)

DESCRIPTION	WIRE GAUGE	REQUIREMENT	AMPERAGE
Temperature Rise & Current Cycling	30 awg	30° C Max. Temperature Rise	2.5 amps (2 circuit)
	26 awg	30° C Max. Temperature Rise	3.0 amps (2 circuit)
	24 awg	30° C Max. Temperature Rise	4.0 amps (2 circuit)
	20 awg	30° C Max. Temperature Rise	5.5 amps (2 circuit)

REVISION: D1	ECR/ECN INFORMATION: EC No: 109530 DATE: 2016 / 10 / 19	TITLE: TEST SUMMARY FOR 46235 LOW FORCE MICRO-FIT CONNECTOR SYSTEM	SHEET No. 2 of 18
DOCUMENT NUMBER: TS-46235-001	CREATED / REVISED BY: JDFOX	CHECKED BY: SSOUSEK	APPROVED BY: FSMITH



TEST SUMMARY

5.1 ELECTRICAL/ENVIRONMENTAL PERFORMANCE RESULTS (cont)

(Note that measured LLCR values are for one mated interface)

WIRE TO BOARD						
ITEM	DESCRIPTION	TREATMENT	REQUIREMENT	MEAN	MINIMUM	MAXIMUM
G R O U P 1	Contact Resistance (Low Level)	Initial	13.0 mΩ Nominal no limit set	12.83 mΩ	12.03 mΩ	13.28 mΩ
		After Initial Durability (Preconditioning) (25 cycles)	20 mΩ MAXIMUM*	0.03 mΩ	-0.40 mΩ	0.63 mΩ
		After Temp Life (240 hrs. @ 105°C)	20 mΩ MAXIMUM*	0.06 mΩ	-0.39 mΩ	0.61 mΩ
		After Reseating (3x M/U)	20 mΩ MAXIMUM*	0.07 mΩ	-0.32 mΩ	0.81 mΩ

* change from initial

WIRE TO WIRE						
ITEM	DESCRIPTION	TREATMENT	REQUIREMENT	MEAN	MINIMUM	MAXIMUM
G R O U P 1	Contact Resistance (Low Level)	Initial	13.0 mΩ Nominal no limit set	12.70 mΩ	11.82 mΩ	13.52 mΩ
		After Initial Durability (Preconditioning) (25 cycles)	20 mΩ MAXIMUM*	0.12 mΩ	-0.31 mΩ	0.78 mΩ
		After Temp Life (240 hrs. @ 105°C)	20 mΩ MAXIMUM*	0.13 mΩ	-0.27 mΩ	0.54 mΩ
		After Reseating (3x M/U)	20 mΩ MAXIMUM*	0.42 mΩ	-0.13 mΩ	1.86 mΩ

* change from initial

REVISION: D1	ECR/ECN INFORMATION: EC No: 109530 DATE: 2016 / 10 / 19	TITLE: TEST SUMMARY FOR 46235 LOW FORCE MICRO-FIT CONNECTOR SYSTEM	SHEET No. 3 of 18
DOCUMENT NUMBER: TS-46235-001	CREATED / REVISED BY: JDFOX	CHECKED BY: SSOUSEK	APPROVED BY: FSMITH



TEST SUMMARY

5.1 ELECTRICAL/ENVIRONMENTAL PERFORMANCE RESULTS (cont)

(Note that measured LLCR values are for one mated interface)

WIRE TO BOARD						
ITEM	DESCRIPTION	TREATMENT	REQUIREMENT	MEAN	MINIMUM	MAXIMUM
G R O U P 2	Contact Resistance (Low Level)	Initial	13.0 mΩ Nominal no limit set	12.99 mΩ	12.58 mΩ	13.51 mΩ
		After Initial Durability (Preconditioning) (25 cycles)	20 mΩ MAXIMUM*	0.01 mΩ	-0.33 mΩ	0.62 mΩ
		After Thermal Shock	20 mΩ MAXIMUM*	-0.15 mΩ	-0.48 mΩ	0.20 mΩ
		After Cyclic Temp and Humidity	20 mΩ MAXIMUM*	-0.14 mΩ	-0.51 mΩ	0.64 mΩ
		After Reseating (3x M/U)	20 mΩ MAXIMUM*	-0.03 mΩ	-0.39 mΩ	0.52 mΩ

* change from initial

WIRE TO WIRE						
ITEM	DESCRIPTION	TREATMENT	REQUIREMENT	MEAN	MINIMUM	MAXIMUM
G R O U P 2	Contact Resistance (Low Level)	Initial	13.0 mΩ Nominal no limit set	13.01 mΩ	12.53 mΩ	13.57 mΩ
		After Initial Durability (Preconditioning) (25 cycles)	20 mΩ MAXIMUM*	0.23 mΩ	-0.41 mΩ	0.66 mΩ
		After Thermal Shock	20 mΩ MAXIMUM*	0.11 mΩ	-0.34 mΩ	0.56 mΩ
		After Cyclic Temp and Humidity	20 mΩ MAXIMUM*	0.10 mΩ	-0.41 mΩ	0.51 mΩ
		After Reseating (3x M/U)	20 mΩ MAXIMUM*	-0.29 mΩ	-0.34 mΩ	0.97 mΩ

* change from initial

REVISION: D1	ECR/ECN INFORMATION: EC No: 109530 DATE: 2016 / 10 / 19	TITLE: TEST SUMMARY FOR 46235 LOW FORCE MICRO-FIT CONNECTOR SYSTEM	SHEET No. 4 of 18
DOCUMENT NUMBER: TS-46235-001	CREATED / REVISED BY: JDFOX	CHECKED BY: SSOUSEK	APPROVED BY: FSMITH



TEST SUMMARY

5.1 ELECTRICAL/ENVIRONMENTAL PERFORMANCE RESULTS (cont)

(Note that measured LLCR values are for one mated interface)

WIRE TO BOARD						
ITEM	DESCRIPTION	TREATMENT	REQUIREMENT	MEAN	MINIMUM	MAXIMUM
G R O U P 3	Contact Resistance (Low Level)	Initial	13.0 mΩ Nominal no limit set	12.94 mΩ	12.23 mΩ	13.61 mΩ
		After Initial Durability (Preconditioning) (25 cycles)	20 mΩ MAXIMUM*	0.02 mΩ	-0.51 mΩ	0.58 mΩ
		After Temp Life (120 hrs. @ 105°C)	20 mΩ MAXIMUM*	0.03 mΩ	-0.50 mΩ	0.35 mΩ
		Vibration	20 mΩ MAXIMUM*	0.04 mΩ	-0.29 mΩ	0.82 mΩ
		Mechanical Shock	20 mΩ MAXIMUM*	0.03 mΩ	-0.53 mΩ	0.34 mΩ

* change from initial

WIRE TO WIRE						
ITEM	DESCRIPTION	TREATMENT	REQUIREMENT	MEAN	MINIMUM	MAXIMUM
G R O U P 3	Contact Resistance (Low Level)	Initial	13.0 mΩ Nominal no limit set	13.05 mΩ	12.37 mΩ	13.71 mΩ
		After Initial Durability (Preconditioning) (25 cycles)	20 mΩ MAXIMUM*	0.15 mΩ	-0.25 mΩ	0.61 mΩ
		After Temp Life (120 hrs. @ 105°C)	20 mΩ MAXIMUM*	0.28 mΩ	-0.21 mΩ	0.76 mΩ
		Vibration	20 mΩ MAXIMUM*	0.44 mΩ	0.07 mΩ	0.93 mΩ
		Mechanical Shock	20 mΩ MAXIMUM*	0.47 mΩ	0.03 mΩ	1.72 mΩ

* change from initial

REVISION: D1	ECR/ECN INFORMATION: EC No: 109530 DATE: 2016 / 10 / 19	TITLE: TEST SUMMARY FOR 46235 LOW FORCE MICRO-FIT CONNECTOR SYSTEM	SHEET No. 5 of 18
DOCUMENT NUMBER: TS-46235-001	CREATED / REVISED BY: JDFOX	CHECKED BY: SSOUSEK	APPROVED BY: FSMITH



TEST SUMMARY

5.1 ELECTRICAL/ENVIRONMENTAL PERFORMANCE RESULTS (cont)

(Note that measured LLCR values are for one mated interface)

WIRE TO BOARD, 15μ" Au						
ITEM	DESCRIPTION	TREATMENT	REQUIREMENT	MEAN	MINIMUM	MAXIMUM
G R O U P 4	Contact Resistance (Low Level)	Initial	13.0 mΩ Nominal no limit set	12.94 mΩ	12.51 mΩ	13.53 mΩ
		After Initial Durability (Preconditioning) (25 cycles)	20 mΩ MAXIMUM*	0.03 mΩ	-0.52 mΩ	0.90 mΩ
		After Temp. Life (120 hrs. @ 105 C)	20 mΩ MAXIMUM*	0.10 mΩ	-0.28 mΩ	1.31 mΩ
		After Mixed Flowing Gas Testing (7 days Unmated)	20 mΩ MAXIMUM*	1.11 mΩ	0.21 mΩ	4.92 mΩ
		After Mixed Flowing Gas Testing (3 days Mated)	20 mΩ MAXIMUM*	1.40 mΩ	0.26 mΩ	6.39 mΩ
		After Thermal Shock	20 mΩ MAXIMUM*	1.01 mΩ	-0.41 mΩ	33.45 mΩ
		After Reseating (3x M/U)	20 mΩ MAXIMUM*	0.88 mΩ	-0.17 mΩ	29.43 mΩ

* change from initial

REVISION: D1	ECR/ECN INFORMATION: EC No: 109530 DATE: 2016 / 10 / 19	TITLE: TEST SUMMARY FOR 46235 LOW FORCE MICRO-FIT CONNECTOR SYSTEM	SHEET No. 6 of 18
DOCUMENT NUMBER: TS-46235-001	CREATED / REVISED BY: JDFOX	CHECKED BY: SSOUSEK	APPROVED BY: FSMITH



TEST SUMMARY

5.1 ELECTRICAL/ENVIRONMENTAL PERFORMANCE RESULTS (cont)

(Note that measured LLCR values are for one mated interface)

WIRE TO BOARD, 30μ" Au						
ITEM	DESCRIPTION	TREATMENT	REQUIREMENT	MEAN	MINIMUM	MAXIMUM
GROUP 4	Contact Resistance (Low Level)	Initial	13.0 mΩ Nominal no limit set	12.80 mΩ	12.40 mΩ	13.34 mΩ
		After Initial Durability (Preconditioning) (25 cycles)	20 mΩ MAXIMUM*	0.02 mΩ	-0.42 mΩ	0.38 mΩ
		After Temp. Life (120 hrs. @ 105 C)	20 mΩ MAXIMUM*	-0.01 mΩ	-0.42 mΩ	0.34 mΩ
		After Mixed Flowing Gas Testing (7 days Unmated)	20 mΩ MAXIMUM*	0.69 mΩ	-0.25 mΩ	2.61 mΩ
		After Mixed Flowing Gas Testing (3 days Mated)	20 mΩ MAXIMUM*	0.71 mΩ	0.08 mΩ	2.79 mΩ
		After Thermal Shock	20 mΩ MAXIMUM*	0.26 mΩ	-0.41 mΩ	1.53 mΩ
		After Reseating (3x M/U)	20 mΩ MAXIMUM*	0.60 mΩ	-0.30 mΩ	2.11 mΩ

* change from initial

REVISION: D1	ECR/ECN INFORMATION: EC No: 109530 DATE: 2016 / 10 / 19	TITLE: TEST SUMMARY FOR 46235 LOW FORCE MICRO-FIT CONNECTOR SYSTEM	SHEET No. 7 of 18
DOCUMENT NUMBER: TS-46235-001	CREATED / REVISED BY: JDFOX	CHECKED BY: SSOUSEK	APPROVED BY: FSMITH



TEST SUMMARY

5.1 ELECTRICAL/ENVIRONMENTAL PERFORMANCE RESULTS (cont)

(Note that measured LLCR values are for one mated interface)

WIRE TO WIRE, 15μ" Au						
ITEM	DESCRIPTION	TREATMENT	REQUIREMENT	MEAN	MINIMUM	MAXIMUM
G R O U P 4	Contact Resistance (Low Level)	Initial	13.0 mΩ Nominal no limit set	13.05 mΩ	12.13 mΩ	14.26 mΩ
		After Initial Durability (Preconditioning) (25 cycles)	20 mΩ MAXIMUM*	0.01 mΩ	-0.35 mΩ	0.44 mΩ
		After Temp. Life (120 hrs. @ 105 C)	20 mΩ MAXIMUM*	0.08 mΩ	-0.37 mΩ	0.46 mΩ
		After Mixed Flowing Gas Testing (7 days Unmated)	20 mΩ MAXIMUM*	2.07 mΩ	-0.52 mΩ	10.28 mΩ
		After Mixed Flowing Gas Testing (3 days Mated)	20 mΩ MAXIMUM*	1.61 mΩ	0.41 mΩ	5.39 mΩ
		After Thermal Shock	20 mΩ MAXIMUM*	3.23 mΩ	0.28 mΩ	33.62 mΩ
		After Reseating (3x M/U)	20 mΩ MAXIMUM*	2.67 mΩ	0.20 mΩ	12.65 mΩ

* change from initial

REVISION: D1	ECR/ECN INFORMATION: EC No: 109530 DATE: 2016 / 10 / 19	TITLE: TEST SUMMARY FOR 46235 LOW FORCE MICRO-FIT CONNECTOR SYSTEM	SHEET No. 8 of 18
DOCUMENT NUMBER: TS-46235-001	CREATED / REVISED BY: JDFOX	CHECKED BY: SSOUSEK	APPROVED BY: FSMITH



TEST SUMMARY

5.1 ELECTRICAL/ENVIRONMENTAL PERFORMANCE RESULTS (cont)

(Note that measured LLCR values are for one mated interface)

WIRE TO WIRE, 30μ" Au						
ITEM	DESCRIPTION	TREATMENT	REQUIREMENT	MEAN	MINIMUM	MAXIMUM
G R O U P 4	Contact Resistance (Low Level)	Initial	13.0 mΩ Nominal no limit set	12.63 mΩ	12.00 mΩ	13.38 mΩ
		After Initial Durability (Preconditioning) (25 cycles)	20 mΩ MAXIMUM*	0.14 mΩ	-0.31 mΩ	0.62 mΩ
		After Temp. Life (120 hrs. @ 105 C)	20 mΩ MAXIMUM*	0.07 mΩ	-0.39 mΩ	0.55 mΩ
		After Mixed Flowing Gas Testing (7 days Unmated)	20 mΩ MAXIMUM*	1.05 mΩ	0.05 mΩ	5.01 mΩ
		After Mixed Flowing Gas Testing (3 days Mated)	20 mΩ MAXIMUM*	1.10 mΩ	0.08 mΩ	7.13 mΩ
		After Thermal Shock	20 mΩ MAXIMUM*	0.86 mΩ	-0.03 mΩ	8.26 mΩ
		After Reseating (3x M/U)	20 mΩ MAXIMUM*	1.34 mΩ	0.23 mΩ	3.88 mΩ

* change from initial

REVISION: D1	ECR/ECN INFORMATION: EC No: 109530 DATE: 2016 / 10 / 19	TITLE: TEST SUMMARY FOR 46235 LOW FORCE MICRO-FIT CONNECTOR SYSTEM	SHEET No. 9 of 18
DOCUMENT NUMBER: TS-46235-001	CREATED / REVISED BY: JDFOX	CHECKED BY: SSOUSEK	APPROVED BY: FSMITH



TEST SUMMARY

5.1 ELECTRICAL/ENVIRONMENTAL PERFORMANCE RESULTS (cont)

(Note that measured LLCR values are for one mated interface)

WIRE TO BOARD						
ITEM	DESCRIPTION	TREATMENT	REQUIREMENT	MEAN	MINIMUM	MAXIMUM
G R O U P 5	Contact Resistance (Low Level)	Initial	13.0 mΩ Nominal no limit set	12.90 mΩ	12.39 mΩ	13.34 mΩ
		After Initial Durability (Preconditioning) (25 cycles)	20 mΩ MAXIMUM*	0.06 mΩ	-0.31 mΩ	0.70 mΩ
		After Temp. Life (120 hrs. @ 105 C)	20 mΩ MAXIMUM*	0.27 mΩ	-0.15 mΩ	1.08 mΩ
		After Thermal Cycling	20 mΩ MAXIMUM*	-0.03 mΩ	-0.37 mΩ	0.63 mΩ
		After Thermal Shock	20 mΩ MAXIMUM*	0.12 mΩ	-0.37 mΩ	0.61 mΩ

* change from initial

WIRE TO WIRE						
ITEM	DESCRIPTION	TREATMENT	REQUIREMENT	MEAN	MINIMUM	MAXIMUM
G R O U P 5	Contact Resistance (Low Level)	Initial	13.0 mΩ Nominal no limit set	12.81 mΩ	12.00 mΩ	13.62 mΩ
		After Initial Durability (Preconditioning) (25 cycles)	20 mΩ MAXIMUM*	0.08 mΩ	-0.50 mΩ	0.62 mΩ
		After Temp. Life (120 hrs. @ 105 C)	20 mΩ MAXIMUM*	0.22 mΩ	-0.62 mΩ	0.84 mΩ
		After Thermal Cycling	20 mΩ MAXIMUM*	0.23 mΩ	-0.48 mΩ	0.85 mΩ
		After Thermal Shock	20 mΩ MAXIMUM*	0.35 mΩ	-0.54 mΩ	1.42 mΩ

* change from initial

REVISION: D1	ECR/ECN INFORMATION: EC No: 109530 DATE: 2016 / 10 / 19	TITLE: TEST SUMMARY FOR 46235 LOW FORCE MICRO-FIT CONNECTOR SYSTEM	SHEET No. 10 of 18
DOCUMENT NUMBER: TS-46235-001	CREATED / REVISED BY: JDFOX	CHECKED BY: SSOUSEK	APPROVED BY: FSMITH



TEST SUMMARY

5.1 ELECTRICAL/ENVIRONMENTAL PERFORMANCE RESULTS (cont)

15μ" Au – 40 cycles				
ITEM	DESCRIPTION	TREATMENT	REQUIREMENT	RESULTS
G R O U P 7	Dielectric Withstanding Voltage (DWV)	Durability (40 M/U cycles) 2200 VAC	No breakdown or flashover	PASS

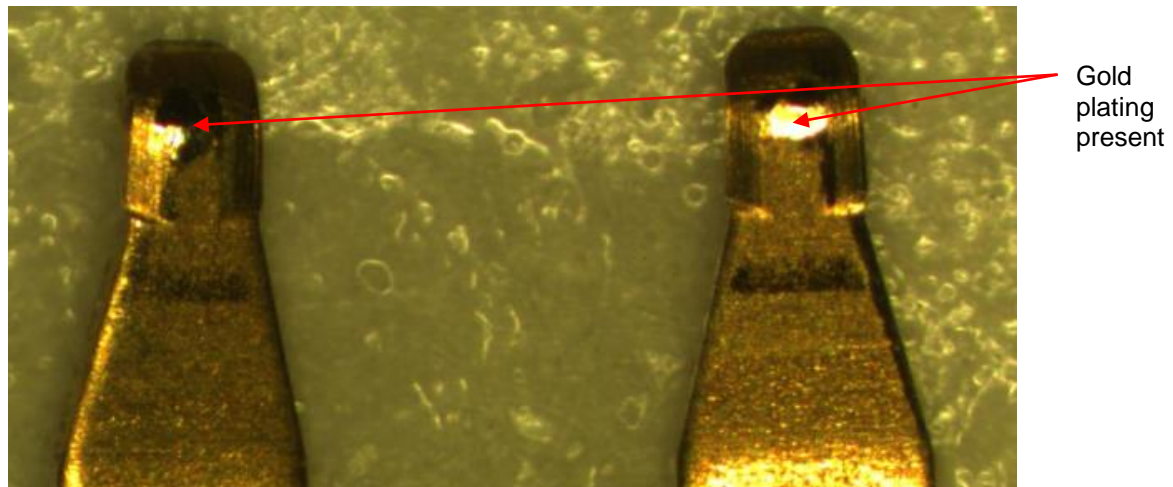

Figure 1 – Contact area shown after 40 cycles

REVISION: D1	ECR/ECN INFORMATION: EC No: 109530 DATE: 2016 / 10 / 19	TITLE: TEST SUMMARY FOR 46235 LOW FORCE MICRO-FIT CONNECTOR SYSTEM	SHEET No. 11 of 18
DOCUMENT NUMBER: TS-46235-001	CREATED / REVISED BY: JDFOX	CHECKED BY: SSOUSEK	APPROVED BY: FSMITH

TEST SUMMARY

5.1 ELECTRICAL/ENVIRONMENTAL PERFORMANCE RESULTS (cont)

15µ" Au – 250 cycles (lubricated)				
ITEM	DESCRIPTION	TREATMENT	REQUIREMENT	RESULTS
G R O U P 7	Dielectric Withstanding Voltage (DWV)	Durability (250 M/U cycles) 2200 VAC	No breakdown or flashover	PASS

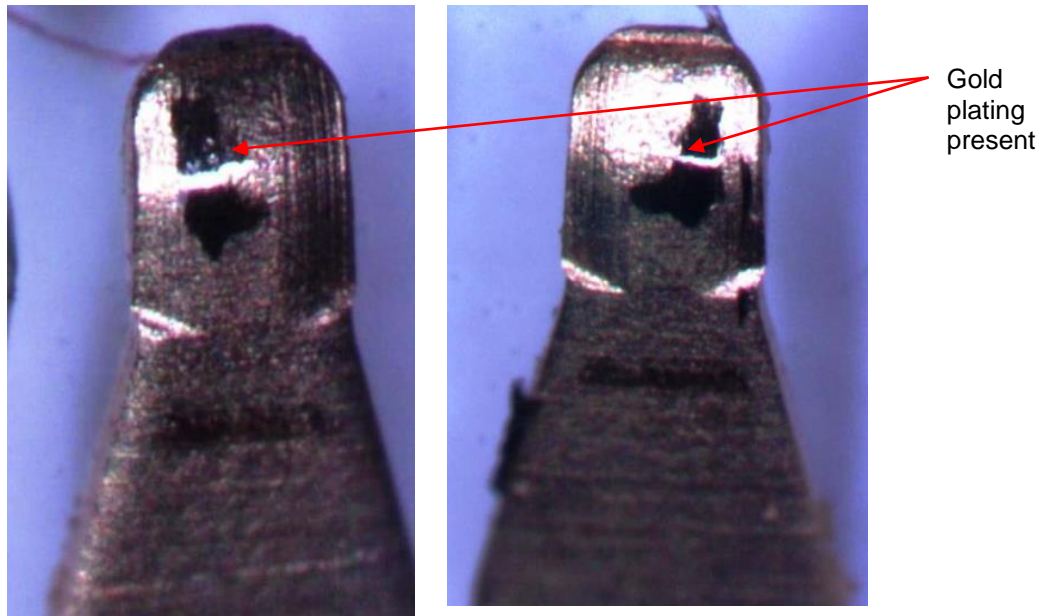

Figure 3 – Contact area shown after 250 cycles

REVISION: D1	ECR/ECN INFORMATION: EC No: 109530 DATE: 2016 / 10 / 19	TITLE: TEST SUMMARY FOR 46235 LOW FORCE MICRO-FIT CONNECTOR SYSTEM	SHEET No. 12 of 18
DOCUMENT NUMBER: TS-46235-001	CREATED / REVISED BY: JDFOX	CHECKED BY: SSOUSEK	APPROVED BY: FSMITH



TEST SUMMARY

5.2 MECHANICAL PERFORMANCE RESULTS

ITEM	DESCRIPTION	TREATMENT	REQUIREMENT	MEAN	MINIMUM	MAXIMUM
1a	2 circuit Connector Mate and Unmate Forces (W-B, 15 μ " Au) <i>**thumb latch removed**</i>	Initial Mating	8.0 N maximum	5.52 N	3.81 N	6.88 N
		Initial Un-Mating	4.0 N maximum	2.93 N	2.43 N	3.57 N
		Final Mating (after 40 cycles)	8.0 N maximum	4.71 N	3.40 N	5.30 N
		Final Un-Mating (after 40 cycles)	4.0 N maximum	3.51 N	1.63 N	4.06 N
1b	2 circuit Connector Mate and Unmate Forces (W-W, 15 μ " Au) <i>**thumb latch removed**</i>	Initial Mating	8.0 N maximum	5.03 N	4.67 N	5.46 N
		Initial Un-Mating	4.0 N maximum	2.30 N	2.13 N	2.58 N
		Final Mating (after 40 cycles)	8.0 N maximum	3.59 N	3.27 N	3.87 N
		Final Un-Mating (after 40 cycles)	4.0 N maximum	2.32 N	2.10 N	2.51 N
1c	12 circuit Connector Mate and Unmate Forces (W-B, 15 μ " Au) <i>**thumb latch removed**</i>	Initial Mating	48.0 N maximum	15.32 N	13.78 N	17.00 N
		Initial Un-Mating	24.0 N maximum	9.79 N	7.83 N	13.15 N
		Final Mating (after 40 cycles)	48.0 N maximum	16.81 N	14.74 N	20.44 N
		Final Un-Mating (after 40 cycles)	24.0 N maximum	13.76 N	11.22 N	16.38 N
1d	12 circuit Connector Mate and Unmate Forces (W-W, 15 μ " Au) <i>**thumb latch removed**</i>	Initial Mating	48.0 N maximum	29.39 N	21.65 N	34.27 N
		Initial Un-Mating	24.0 N maximum	18.10 N	13.22 N	21.98 N
		Final Mating (after 40 cycles)	48.0 N maximum	24.12 N	19.84 N	28.23 N
		Final Un-Mating (after 40 cycles)	24.0 N maximum	19.69 N	14.57 N	23.78 N

REVISION: D1	ECR/ECN INFORMATION: EC No: 109530 DATE: 2016 / 10 / 19	TITLE: TEST SUMMARY FOR 46235 LOW FORCE MICRO-FIT CONNECTOR SYSTEM	SHEET No. 13 of 18
DOCUMENT NUMBER: TS-46235-001	CREATED / REVISED BY: JDFOX	CHECKED BY: SSOUSEK	APPROVED BY: FSMITH



TEST SUMMARY

5.2 MECHANICAL PERFORMANCE RESULTS (cont)

ITEM	DESCRIPTION	TREATMENT	REQUIREMENT	MEAN	MINIMUM	MAXIMUM
1e	24 circuit Connector Mate and Unmate Forces (W-B, 15μ" Au) <i>**thumb latch removed**</i>	Initial Mating	96.0 N maximum	37.93 N	33.42 N	42.50 N
		Initial Un-Mating	48.0 N maximum	21.82 N	19.98 N	23.35 N
		Final Mating (after 40 cycles)	96.0 N maximum	34.04 N	31.42 N	36.26 N
		Final Un-Mating (after 40 cycles)	48.0 N maximum	25.35 N	23.77 N	27.13 N
1f	24 circuit Connector Mate and Unmate Forces (W-W, 15μ" Au) <i>**thumb latch removed**</i>	Initial Mating	96.0 N maximum	52.61 N	47.20 N	61.89 N
		Initial Un-Mating	48.0 N maximum	29.87 N	27.53 N	32.68 N
		Final Mating (after 40 cycles)	96.0 N maximum	43.80 N	40.78 N	45.15 N
		Final Un-Mating (after 40 cycles)	48.0 N maximum	36.45 N	32.49 N	39.52 N

REVISION: D1	ECR/ECN INFORMATION: EC No: 109530 DATE: 2016 / 10 / 19	TITLE: TEST SUMMARY FOR 46235 LOW FORCE MICRO-FIT CONNECTOR SYSTEM	SHEET No. 14 of 18
DOCUMENT NUMBER: TS-46235-001	CREATED / REVISED BY: JDFOX	CHECKED BY: SSOUSEK	APPROVED BY: FSMITH



TEST SUMMARY

5.2 MECHANICAL PERFORMANCE RESULTS (cont)

ITEM	DESCRIPTION	TREATMENT	REQUIREMENT	MEAN	MINIMUM	MAXIMUM
2	Terminal Retention Force (in housing)	-----	24.5 N per contact minimum	36.4 N	35.4 N	37.9 N
3	Terminal Insertion Force (in housing)	-----	14.7 N per contact maximum	2.9 N	2.2 N	4.2 N
4	Wire Pullout Force (from terminal)	20 awg	57.8 N minimum	107.4 N	97.0 N	116.0 N
		22 awg	35.6 N minimum	80.7 N	71.8 N	86.0 N
		24 awg	22.2 N minimum	50.45 N	46.0 N	56.0 N
		26 awg	13.3 N minimum	28.7 N	24.0 N	31.0 N
		28 awg	8.9 N minimum	17.1 N	15.0 N	19.0 N
		30 awg	6.6 N minimum	9.4 N	9.0 N	10.0 N
5	Normal Force (nominal deflection)	Initial	50 g per contact beam minimum	134.8 g	120.8 g	143.3 g
		After one cycle	50 g per contact beam minimum	134.3 g	121.8 g	143.6 g

REVISION: D1	ECR/ECN INFORMATION: EC No: 109530 DATE: 2016 / 10 / 19	TITLE: TEST SUMMARY FOR 46235 LOW FORCE MICRO-FIT CONNECTOR SYSTEM	SHEET No. 15 of 18
DOCUMENT NUMBER: TS-46235-001	CREATED / REVISED BY: JDFOX	CHECKED BY: SSOUSEK	APPROVED BY: FSMITH



TEST SUMMARY

6.0 APPENDIX 1

6.1 TEST SEQUENCES

GROUP 1	GROUP 2	GROUP 3	GROUP 4	GROUP 5	GROUP 7
Visual Exam	Visual Exam	Visual Exam	Visual Exam	Visual Exam	Visual Exam
LLCR	LLCR	LLCR	LLCR	LLCR	LLCR
Preconditioning Durability (25 M/U cycles)	Preconditioning Durability (25 M/U cycles)	Preconditioning Durability (25 M/U cycles)	Preconditioning Durability (25 M/U cycles)	Preconditioning Durability (25 M/U cycles)	Durability (40 M/U cycles)
LLCR	LLCR	Temp Life (120 hrs @ 105°)	LLCR	LLCR	LLCR
Temp Life (240 hrs @ 105°)	Thermal Shock	LLCR	Temp Life (120 hrs @ 105°)	Temp Life (120 hrs @ 105°)	DWV
LLCR	LLCR	Vibration	LLCR	LLCR	Visual Exam
Reseating	Cyclic Temp and Humidity	LLCR	MFG (7 days Unmated)	Thermal Cycling	
LLCR	LLCR	Mechanical Shock	LLCR	LLCR	
	Reseating	LLCR	MFG (3 days Mated)	Thermal Shock	
	LLCR		LLCR	LLCR	
			Thermal Shock	Reseating	
			LLCR	LLCR	
			Reseating		
			LLCR		

REVISION: D1	ECR/ECN INFORMATION: EC No: 109530 DATE: 2016 / 10 / 19	TITLE: TEST SUMMARY FOR 46235 LOW FORCE MICRO-FIT CONNECTOR SYSTEM	SHEET No. 16 of 18
DOCUMENT NUMBER: TS-46235-001	CREATED / REVISED BY: JDFOX	CHECKED BY: SSOUSEK	APPROVED BY: FSMITH



TEST SUMMARY

6.2 TEST PROCEDURES

<u>ITEM</u>	<u>TEST CONDITION</u>
LOW LEVEL CONTACT RESISTANCE (LLCR)	per EIA-364-TP-23
INITIAL MATING FORCE	per EIA-364-TP-13
INITIAL UN-MATING FORCE	per EIA-364-TP-13
DURABILITY	per EIA-364-TP-09
RANDOM VIBRATION	per EIA-364-TP-28, Test Cond. VII
MECHANICAL SHOCK	per EIA-364-TP-27 Peak Value: 50 G; Duration: 11 mSec.; Waveform: Half Sine; # Shocks Direction: 3 shocks/3 axes (18 total)
NORMAL FORCE	per EIA-364-04 (perpendicular force)
THERMAL AGING (Temp life)	per EIA-364-TP-17, method A
THERMAL SHOCK	per EIA-364-TP-32
CYCLIC HUMIDITY	per EIA-364-TP-31 Test Temp: +40° ± 2° C Relative Humidity: 90 to 95%; Test Duration: 96 hours
MIXED FLOWING GAS (MFG)	per EIA-364-TP-65, Option 2, Class IIA
Dielectric Withstanding Voltage (DWV)	per EIA-364-TP-20 Method B
Insulation Resistance	per EIA-364-TP-21
Current Carrying Capacity (CCC)	per EIA-364-TP-70 Method 2

REVISION: D1	ECR/ECN INFORMATION: EC No: 109530 DATE: 2016 / 10 / 19	TITLE: TEST SUMMARY FOR 46235 LOW FORCE MICRO-FIT CONNECTOR SYSTEM	SHEET No. 17 of 18
DOCUMENT NUMBER: TS-46235-001	CREATED / REVISED BY: JDFOX	CHECKED BY: SSOUSEK	APPROVED BY: FSMITH



TEST SUMMARY

7.0 REVISION HISTORY

Revision Level:	Created / Revised By:	Revision Description:	Date of Revision
A	T. Gregori	Initial "A" Release	7/09/08
B	T. Gregori	Revised Group 4 data based on test results, section 5.1	7/28/08
C	T. Gregori	T-Rise table added; Group 7 250 cycle table added	11/20/08
D	T. Gregori	Revised mate / un-mate force; added total forces for 2, 12 and 24 ckts (items 1a thru 1f)	8/5/09
D1	JDFOX	Add series detail to sections 2.1 & 2.1.1	10/19/16

REVISION: D1	ECR/ECN INFORMATION: EC No: 109530 DATE: 2016 / 10 / 19	TITLE: TEST SUMMARY FOR 46235 LOW FORCE MICRO-FIT CONNECTOR SYSTEM	SHEET No. 18 of 18
DOCUMENT NUMBER: TS-46235-001	CREATED / REVISED BY: JDFOX	CHECKED BY: SSOUSEK	APPROVED BY: FSMITH